

37-8.26.3V-BL2

Floor Standing Bath Set with Volume Hand Shower

Requires SS-FL8.3 concealed rough

Hand Shower Flow Rate: 1.75 GPM

Note: Some building codes require remote pressure balance valves for anti-scald

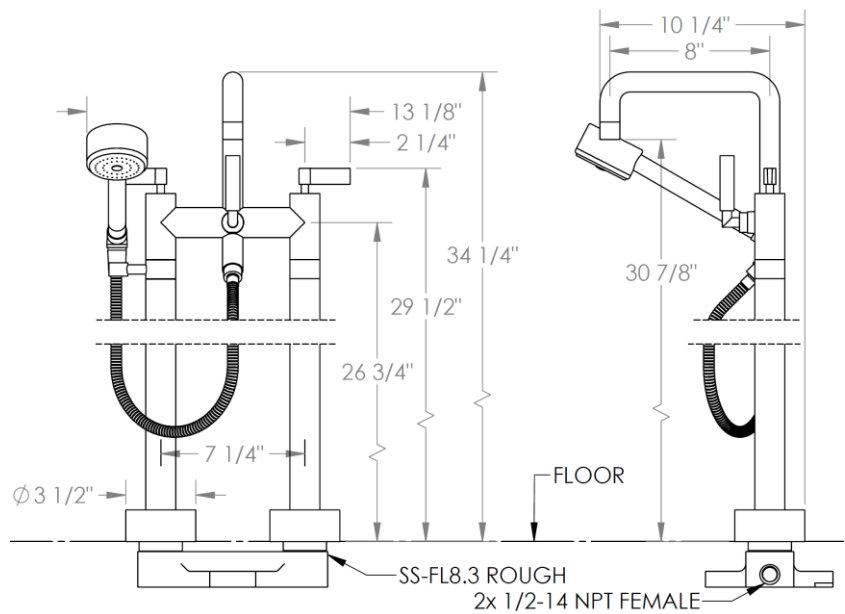
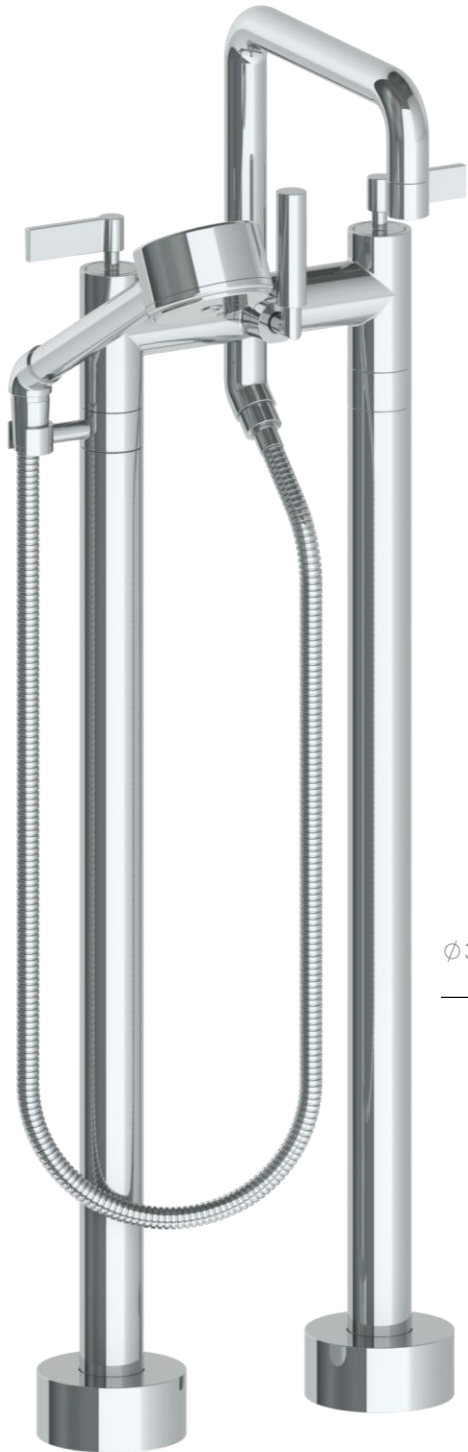

Meets the applicable requirements of ASME A112.18.1-2005/CSA B125.1-05, entitled "Plumbing Supply Fittings"

WATERMARK DESIGNS 4/9/2019

350 Dewitt Ave Brooklyn NY 11207 USA T 718 257 2800 F 718 257 2144 info@watermark-designs.com